



ASK & EMBLA Family

Mounting

ASK & EMBLA can be mounted in three different ways. Recessed in a suspended ceiling, in a surface mount frame or recessed in a skylight frame (for suspended ceiling).

Recessed installation

- 1.) Remove the acoustic panel.

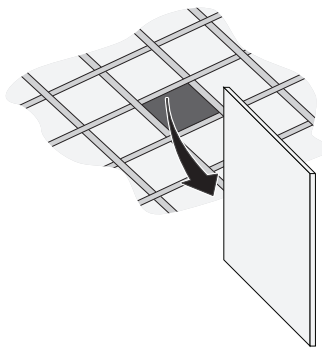

- 2.) If seismic support is required: assemble the brackets on the luminaire frame. NOTE: the brackets might be preassembled.

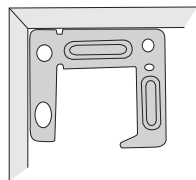

- 3.) Lift the luminaire through the ceiling opening.

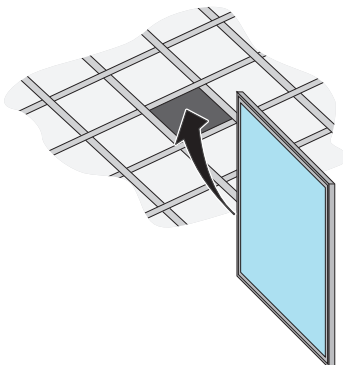

- 4.) Be sure to angle the luminaire in order to get it through the ceiling opening.

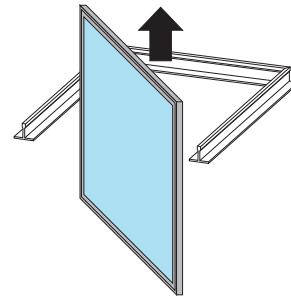

- 5.) Perform the electrical installation according to standards and regulations in your region (see page 3: "Electrical installation").

- 6.) Place the luminaire in desired position.

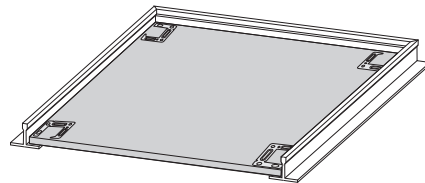

- 7.) US version only: If seismic support is required - fold the brackets and make sure the hooks are outside of the luminaire frame.

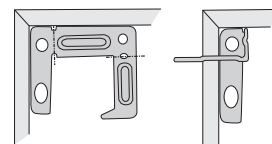

Surface mount frame installation

- 1.) Assemble the frame.
No screws necessary

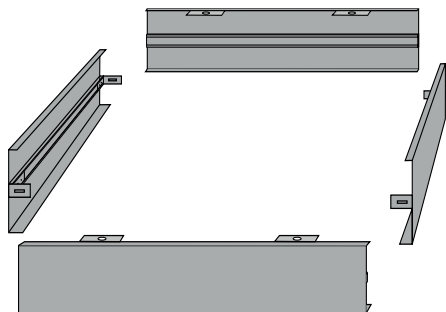

- 2.) Fasten the frame securely to the ceiling.
Use screws and plugs suitable for your ceiling.

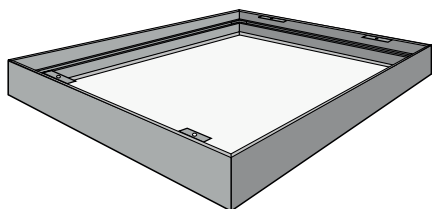

- 3.) Remove one of the side panels of the frame. Insert the luminaire.

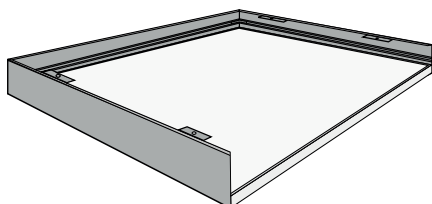

- 4.) Perform the electrical installation according to standards and regulations in your region (see page 3: "Electrical installation").
- 5.) Attach the side panel.

Skylight frame installation

- 1.) Assemble the frame with the screws enclosed in the package

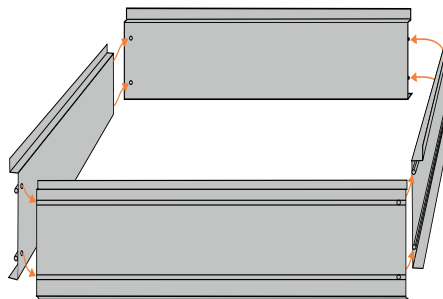

- 2.) Place the frame in the drop ceiling
- 3.) Place the luminaire in the skylight frame.

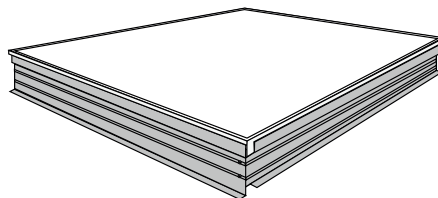

- 4.) Perform electrical installation according to standards (see page 3: "Electrical installation").

Electrical Installation

Disconnect power before installation, maintenance or service.

EU WAGO
Connect the WAGO connectors.

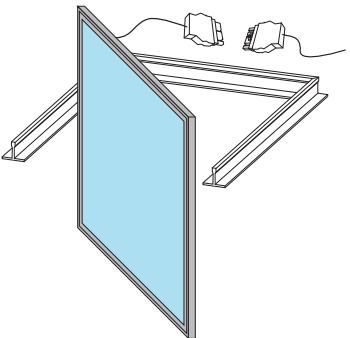

EU Terminal
Connect the two DALI wires to the orange terminals DA+ and DA-, DALI is polarity insensitive. Connect neutral (N) to white terminal, line (L) to black terminal and protective ground (⊕) to green terminal.

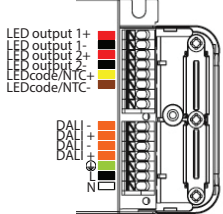

ASK Data

Maximum circuit breaker loading (no of luminaires):	@230V	B10	B13	B16	C10	C13	C16
		43	56	69	43	56	69
Driver size LxWxH (mm):	155x80x30						
Format LxW	EU (mm): 600x600, 606x600, (1200x300)						
Light source energy class:	F						
User replaceable light source:	No						

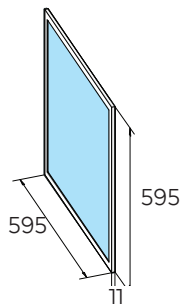

P/N:
ASK IP44: 100001
ASK IP54: 100011
Weight 3,65 kg

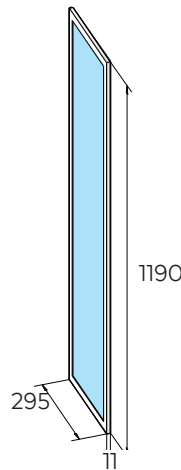

P/N:
ASK IP44: 100039
Weight 3,59 kg

EMBLA Data

Maximum circuit breaker loading (no of luminaires):	B10	B13	B16	C10	C13	C16	
EMBLA HIGH FLUX	@230V	43	56	69	43	56	69
Maximum circuit breaker loading (no of luminaires):	B10	B13	B16	C10	C13	C16	
EMBLA DEEP DIM:	@230V	21	27	33	21	27	33
Driver size LxWxH (mm):	155x80x30 (EMBLA HIGH FLUX)						
Format LxW	EU (mm): 600x600						
Light source energy class:	F						
User replaceable light source:	No						

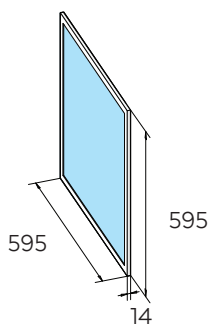

P/N:
 EMBLA HIGH FLUX: 100033
 EMBLA DEEP DIM: 100035
 Weight 4 kg

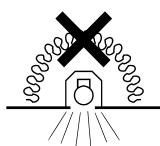

Do not cover luminaire and driver with thermally insulating material

Warning

- Disconnect or turn power off before installation, maintenance or service.
- Installation requires knowledge of luminaire’s electrical systems. If not qualified, do not attempt installation. Contact a qualified electrician.
- Brainlit’s luminaires must be installed in compliance with international wiring regulations (EN, IEE, NEC etc.).
- Secure luminaire compatibility with input voltage and frequency.
- To prevent wiring damage or abrasion, do not expose wiring to edges of sheet metal or sharp objects.
- Risk of fire or electric shock. Keep combustible and other inflammable materials away from lamp/lens.
- The luminaire and driver is not suitable for covering with thermally insulating material.
- Do not operate in close proximity to persons, inflammable materials or substances affected by heat or drying.
- Wear gloves and safety glasses when removing luminaire from carton, installing, servicing or performing maintenance.
- Do not touch enclosure or light source.
- Allow lamp/luminaire to cool down before handling.
- The connecting cable is not waterproof.
- No user serviceable parts inside of luminaire.
- Luminaire to be independently supported to building structure.
- Avoid direct eye exposure to light source when luminaire is on.

This document contains information that is subject to change without notice. This document is solely intended for, and may only be used for, the purpose of providing luminaire products to the BrainLit BioCentric Lighting System. The performance indications for BrainLit products set forth in this document are based on, and conditioned on, the products being used solely in the BrainLit BioCentric Lighting System. However, this document shall not be deemed a product warranty, whether express or implied. The BrainLit product warranty is solely contained in the purchase agreement with each customer. This document is subject to BrainLit AB’s copyright. No part of this document may be reproduced or transmitted in any form or by any means, or shared with any third party, without the prior written approval of BrainLit AB. BrainLit products may be protected by one or more patents and by copyright and design rights. “BrainLit” and “BioCentric Lighting” are registered trade marks of BrainLit AB. This document does not confer upon the recipient a license to any of BrainLit intellectual property rights.