



TYR Spotlight

Mounting

Recessed installation

- 1.) Make a hole in the ceiling to fit the cut-out diameter measurement (d) of the luminaire (93 mm).

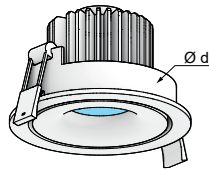
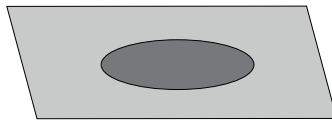

- 2.) Perform the electrical installation according to standards and regulations in your region, see "Electrical installation" below.

- 3.) Fold up the retention clamps and press the luminaire through the hole. Make sure the clamps grip to the ceiling.

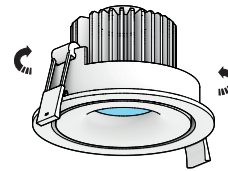
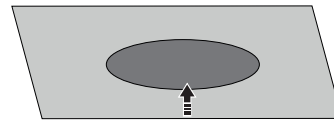

- 4.) Twist and tilt the luminaire to light up the desired area. See product specification for possible angles.

Electrical Installation

Disconnect power before installation, maintenance or service.

EU WAGO

Connect the WAGO connectors.

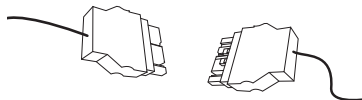

EU terminal

Connect the two DALI wires to the orange terminals DA+ and DA-. DALI is polarity insensitive. Connect neutral (N) to white terminal, line (L) to black terminal.

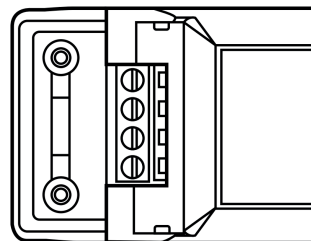

Data

Article no:	100004 100028 (Sunspot, 1800K-4000K)
Maximum circuit breaker loading (no of luminaires):	B10 B13 B16 C10 C13 C16 @230V 66 86 106 66 86 106
Weight (kg)	0,8
Driver size LxWxH (mm):	185x44x31
Light source energy class:	E
User replaceable light source:	No

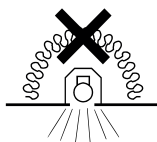
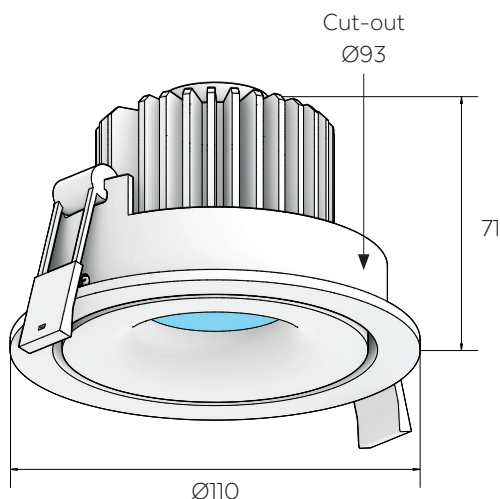

Do not cover luminaire and driver with thermally insulating material

Warning

- Disconnect or turn power off before installation, maintenance or service.
- Installation requires knowledge of luminaire's electrical systems. If not qualified, do not attempt installation. Contact a qualified electrician.
- Brainlit's luminaires must be installed in compliance with international wiring regulations (EN, IEE, NEC etc.).
- Secure luminaire compatibility with input voltage and frequency.
- To prevent wiring damage or abrasion, do not expose wiring to edges of sheet metal or sharp objects.
- Risk of fire or electric shock. Keep combustible and other inflammable materials away from lamp/lens.
- The luminaire is not suitable for covering with thermally insulating material.
- Do not operate in close proximity to persons, inflammable materials or substances affected by heat or drying.
- Wear gloves and safety glasses when removing luminaire from carton, installing, servicing or performing maintenance.
- Do not touch enclosure or light source.
- Allow lamp/luminaire to cool down before handling.
- The connecting cable is not waterproof.
- No user serviceable parts inside of luminaire.
- Luminaire to be independently supported to building structure.
- Avoid direct eye exposure to light source when luminaire is on.

This document contains information that is subject to change without notice. This document is solely intended for, and may only be used for, the purpose of providing luminaire products to the BrainLit BioCentric Lighting System. The performance indications for BrainLit products set forth in this document are based on, and conditioned on, the products being used solely in the BrainLit BioCentric Lighting System. However, this document shall not be deemed a product warranty, whether express or implied. The BrainLit product warranty is solely contained in the purchase agreement with each customer. This document is subject to BrainLit AB's copyright. No part of this document may be reproduced or transmitted in any form or by any means, or shared with any third party, without the prior written approval of BrainLit AB. BrainLit products may be protected by one or more patents and by copyright and design rights. "BrainLit" and "BioCentric Lighting" are registered trade marks of BrainLit AB. This document does not confer upon the recipient a license to any of BrainLit intellectual property rights.